

⚡ Specifications

Nominal Voltage(V)

12V

Nominal Capacity

20 hour rate	(1.8A to 10.50V)	36Ah
10 hour rate	(3.42A to 10.50V)	34.2Ah
5 hour rate	(6.12A to 10.20V)	30.6Ah
1 C	(36A to 9.60V)	20.4Ah
3 C	(108A to 9.60V)	14.4Ah

Weight

Approx. 11.0kg(24.2Lbs.)

Internal Resistance (at 1KHz)

Approx. 6.3 mΩ

Maximum Discharge Current for

5 seconds: 540A

Charging Methods at 25°C(77°F)

Cycle use:	
Charging Voltage	14.4 to 15.0V
Coefficient	-5.0mV/°C/cell
Maximum Charging Current :	10.8A
Standby use:	
Float Charging Voltage	13.5 to 13.8V
Coefficient	-3.0mV/°C/cell

Operating Temperature Range

Charge	-15°C(5°F)	to	40°C(104°F)
Discharge	-15°C(5°F)	to	50°C(122°F)
Storage	-15°C(5°F)	to	40°C(104°F)

Charge Retention (shelf life) at 20°C(68°F)

1 month	97%
3 month	92%
6 month	85%

Case Material

ABS UL94 HB

Option: Flammability resistance of (UL94 V-0)

Terminal

F4



⚡ Dimensions

Length (L)

197±²₁ (7.76±^{0.08}_{0.04})

Width (W)

131±²₁ (5.16±^{0.08}_{0.04})

Height (H)

159±²₁ (6.26±^{0.08}_{0.04})

Overall Height (HT)

180±²₁ (7.09±^{0.08}_{0.04})

mm(inch)

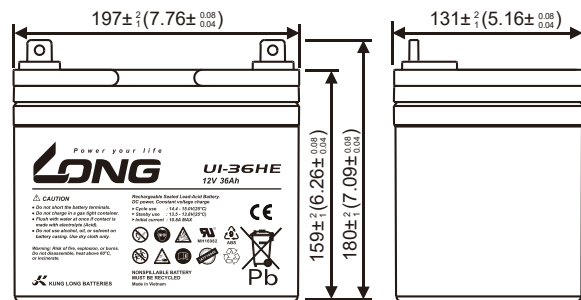
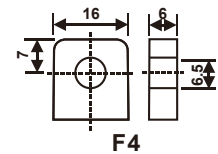
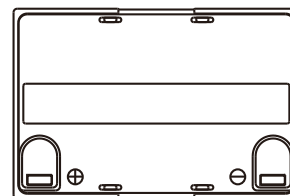

(V) FOR 12V BATTERY Discharge Time VS. Discharge Current (25°C)

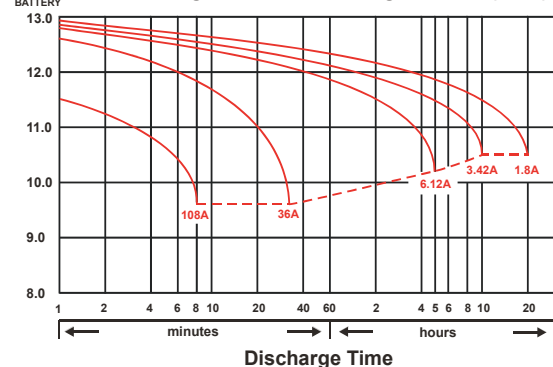

Effect of Temperature on Capacity 25°C(77°F)

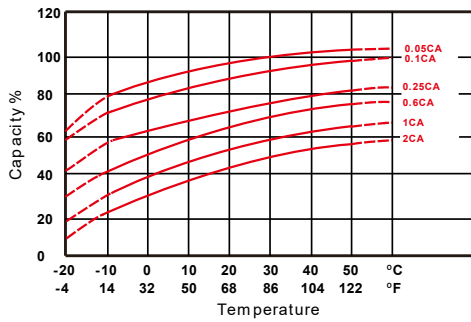

Capacity Retention Characteristic

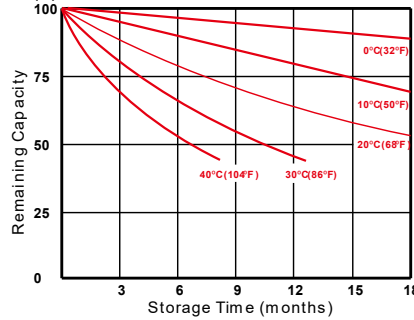

Cycle Service Life

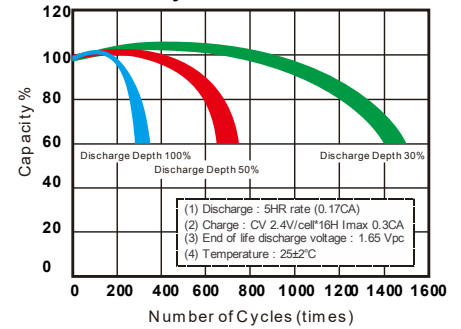

- PERFORMANCE DATA

Discharge Rates in Watts to Various End Voltages at 25°C(77°F)

End Voltage		1.85V	1.80V	1.75V	1.70V	1.67V	1.65V	1.60V
10	min	140	151	156	160	164	167	170
15	min	119	123	126	129	131	133	135
30	min	74.8	76.6	77.5	78.2	78.7	79.0	79.3
45	min	56.2	57.5	58.0	58.3	58.6	58.9	59.1
60	min	42.0	43.2	44.0	44.5	45.0	45.3	45.6
90	min	32.0	32.4	32.7	33.0	33.3	33.5	33.8
120	min	22.0	23.1	23.8	24.2	24.4	24.6	24.8
180	min	14.8	15.4	15.9	16.3	16.6	16.8	17.0
240	min	11.8	12.3	12.6	12.8	12.9	12.9	13.0
300	min	10.4	10.7	11.1	11.3	11.4	11.5	11.6
600	min	5.13	5.41	5.60	5.65	5.68	5.72	5.80
1200	min	3.24	3.33	3.43	3.45	3.49	3.52	3.55

- Discharge Rates in Amperes to Various End Voltages at 25°C(77°F)

End Voltage		1.85V	1.80V	1.75V	1.70V	1.67V	1.65V	1.60V
10	min	78.5	83.9	88.9	91.7	93.5	95.0	95.5
15	min	57.0	60.2	63.2	66.2	69.2	71.2	72.2
30	min	32.8	34.6	36.2	37.8	39.2	40.0	40.5
45	min	26.7	29.2	30.0	30.3	30.6	30.8	31.0
60	min	19.9	20.6	21.0	21.3	21.6	21.9	22.0
90	min	16.0	16.2	16.6	16.8	17.0	17.3	17.3
120	min	11.7	12.2	12.6	12.7	12.7	12.8	12.9
180	min	8.39	8.74	9.01	9.23	9.39	9.51	9.63
240	min	6.79	7.08	7.22	7.31	7.37	7.39	7.41
300	min	5.75	5.99	6.08	6.12	6.14	6.16	6.17
600	min	3.23	3.34	3.43	3.49	3.53	3.55	3.56
1200	min	1.72	1.77	1.80	1.82	1.83	1.84	1.85

All data on the spec. sheet is an average value:

The tolerance range : $X < 6\text{min}$ (+15%~-15%), $6\text{min} \leq X < 10\text{min}$ (+12%~-12%), $10\text{min} \leq X < 60\text{min}$ (+8%~-8%), $X \geq 60\text{min}$ (+5%~-5%)

170326-1G